

AP116

 **GEBERIT**

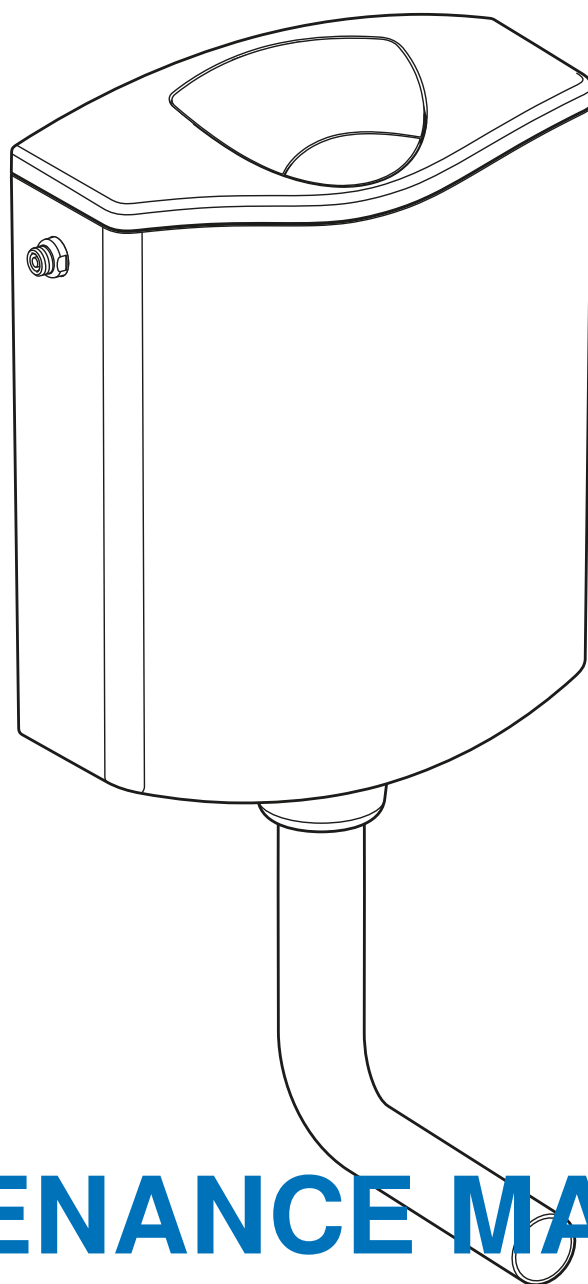

MAINTENANCE MANUAL

INSTANDHALTUNGSANLEITUNG

MANUEL D'ENTRETIEN

ISTRUZIONI PER LA MANUTENZIONE

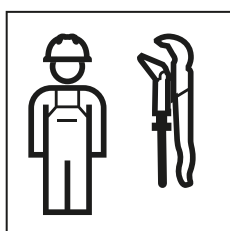



1

1

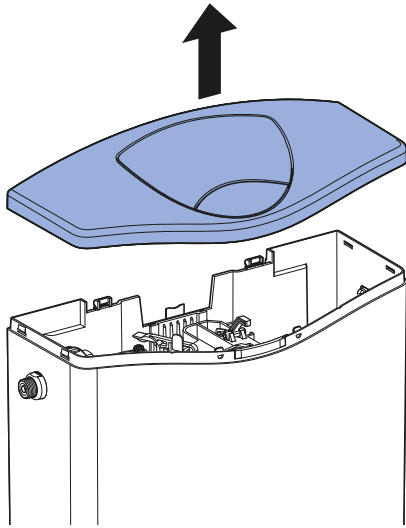

2

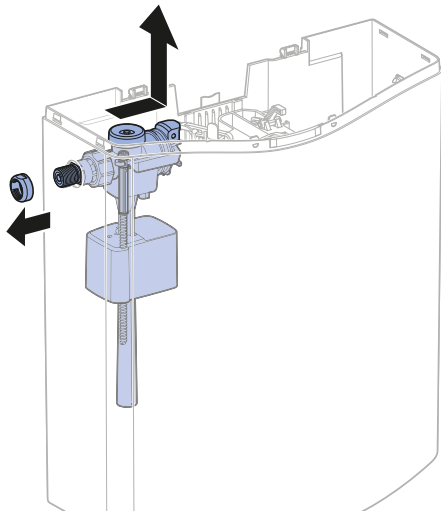

2

1

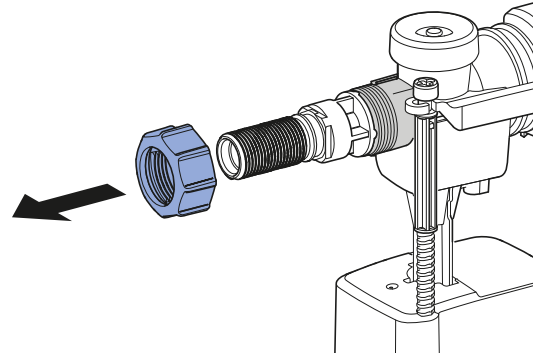

2

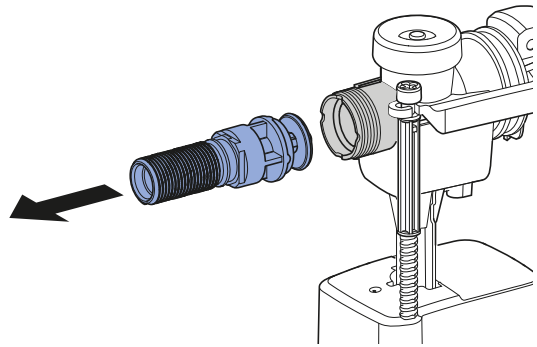

3

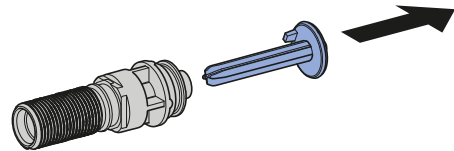

4

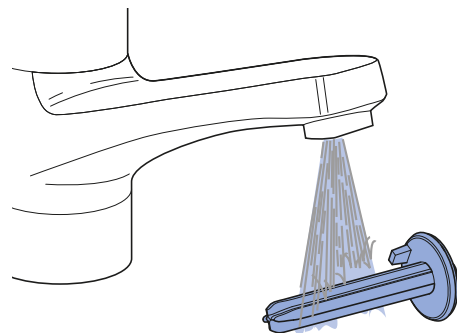

3

1

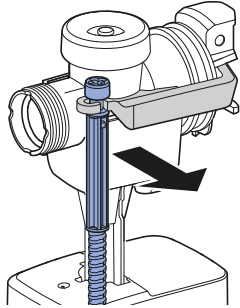

2

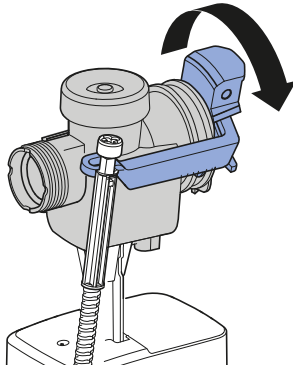

3

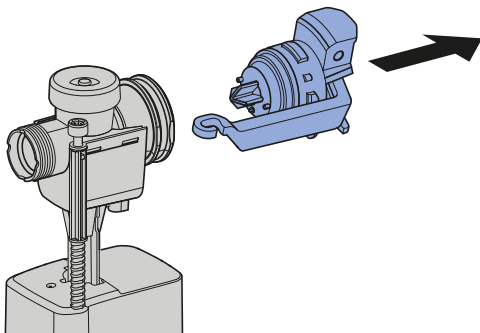

4

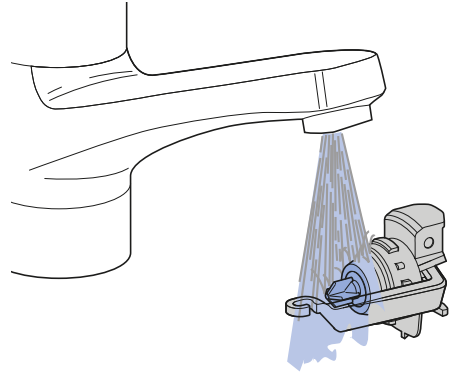

i

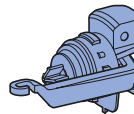
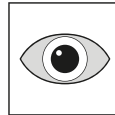

4

1

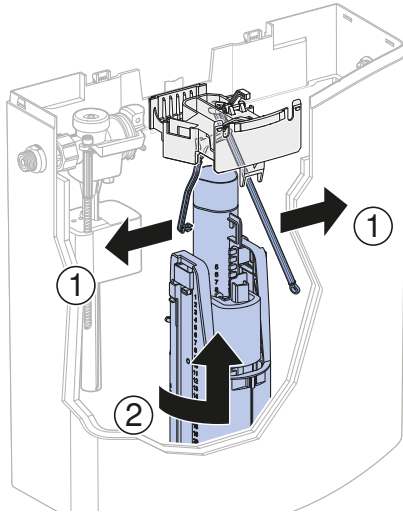

2

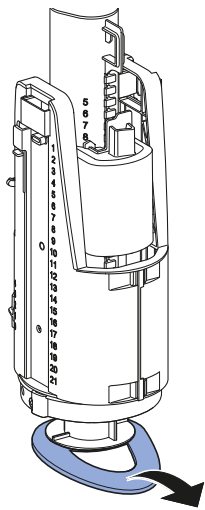

3

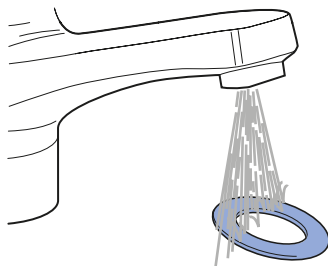

i

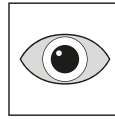

5

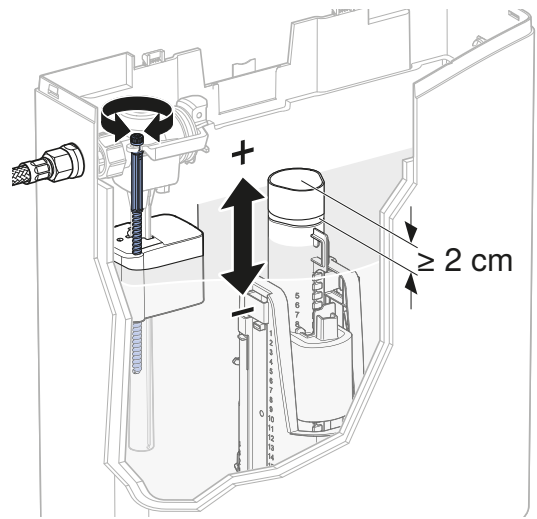

6

1

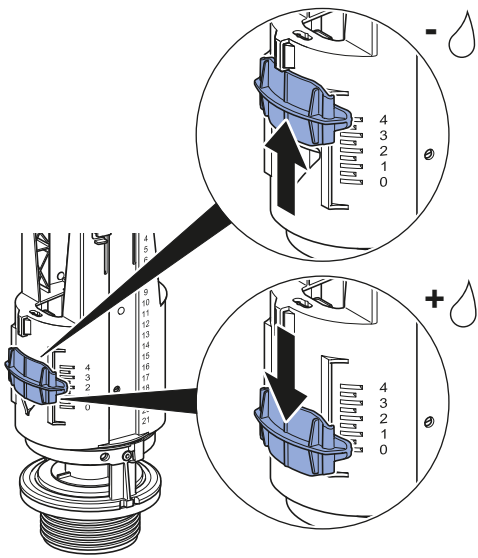
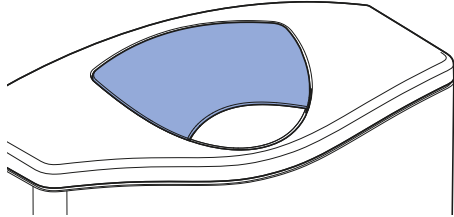

2

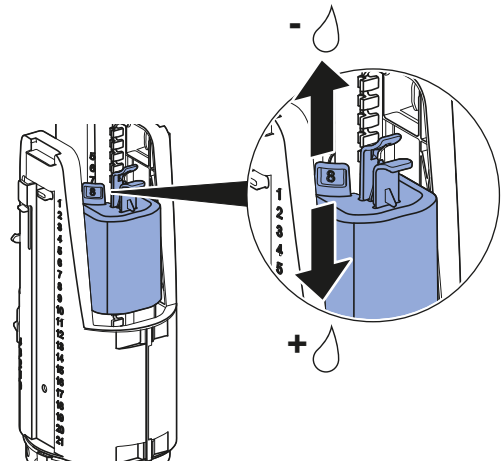
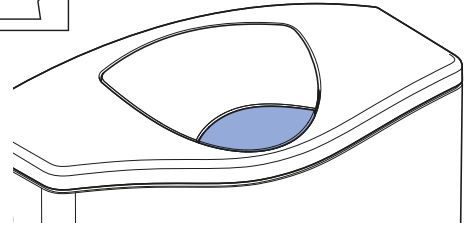

Geberit International AG
Schachenstrasse 77, CH-8645 Jona
documentation@geberit.com
www.geberit.com

